



# *HOTEL SOLUTIONS*



**KNX Approved  
Training Center**

**In Compliance with  
International Standards**

**Products used  
in 106 Countries**



**More than 2,500  
Employees**

**Design & Production  
in Turkey**

# COMFORTABLE | AESTHETIC | CUSTOMISABLE | FULL INTEGRATION

Guest Room Management System (GRMS) from EAE Technology is designed to ensure an exemplary and gratifying experience for your guests. Our intelligent solutions are based on interactive technology that compliments the exceptional experience you want for your guests.



- Easy to operate with complete visibility into all aspects of the business
- Solutions that add to the aesthetic appeal
- Deactivating the room utilities when the customer is out
- Easy to operate with complete visibility into all aspects of the business



# COMFORTABLE

*Easy to operate with complete visibility into all aspects of the business*



*Lighting Control*



*Shutter/Blind Control*



*Heating/Cooling Control*

*Fancoil, VRF, VRV, Air Conditioning  
Central Air Package Units etc.*

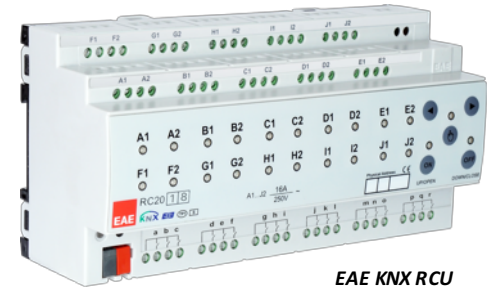

**EAE KNX RCU**  
ROOM CONTROL UNIT





# AESTHETIC

*Solutions that add to the aesthetic appeal*

**rosa**



*Metal and Glass Surface*



*Touch Button*



*All-in-one thermostat and switch*



# AESTHETIC

*Solutions that add to the aesthetic appeal*

 **oria**



*Plastic Surface*



*Push Button*



*All-in-one thermostat and switch*





# ENERGY EFFICIENCY

*Thanks to deactivating the room utilities when the customer is out.*



*Lighting Control*



*Air Condition Control*



*Dim Control*



**EAE CARD HOLDER**



**EAE PD100  
PRESENCE DETECTOR**



**Magnetic Switch**

	4 FRI 18 46%	1 SAT 19 85%	0 SUN 20 35%
	2 159.00	<b>Jon Snow - Confirmed</b> <b>682349544</b>	
	Bran S	<b>Check-in / Out</b> 8/9/2016 - 8/12/2016	
	Tyrian Lannister	<b>Guests</b> 2	
		<b>Arrival Time</b> 11:00 AM ▾	
	Ned S	<b>Total</b> \$299.00	
	Stark	<b>Balance Due</b> <b>\$99.00</b>	
	Petyr Bae		
	3 149.00	2 159.00	
	Sarah Mormont	Jon S	

# FULL INTEGRATION

KNX gives us a chance to be competitive with all hotel management systems.



- Rooms management
- The database
- Reservations
- Front office (Front Desk)
- Cashiering
- Night Audit
- Conference & Catering Management







# Integration into BMS Systems

The following platforms are easily integrated with KNX systems.

- BACnet
- Modbus
- OPC
- LonWorks
- M-Bus

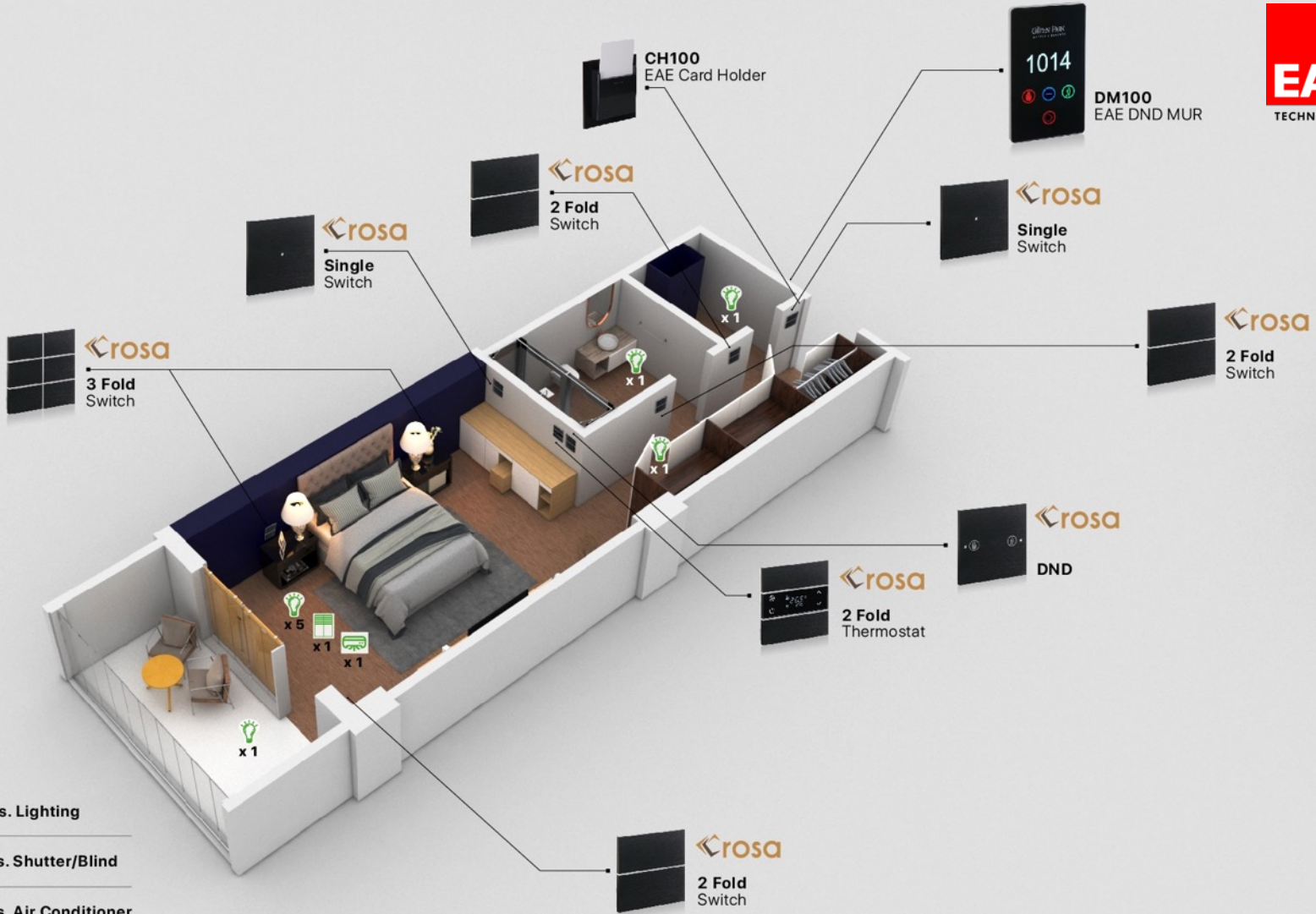



 x 9 pcs. Lighting







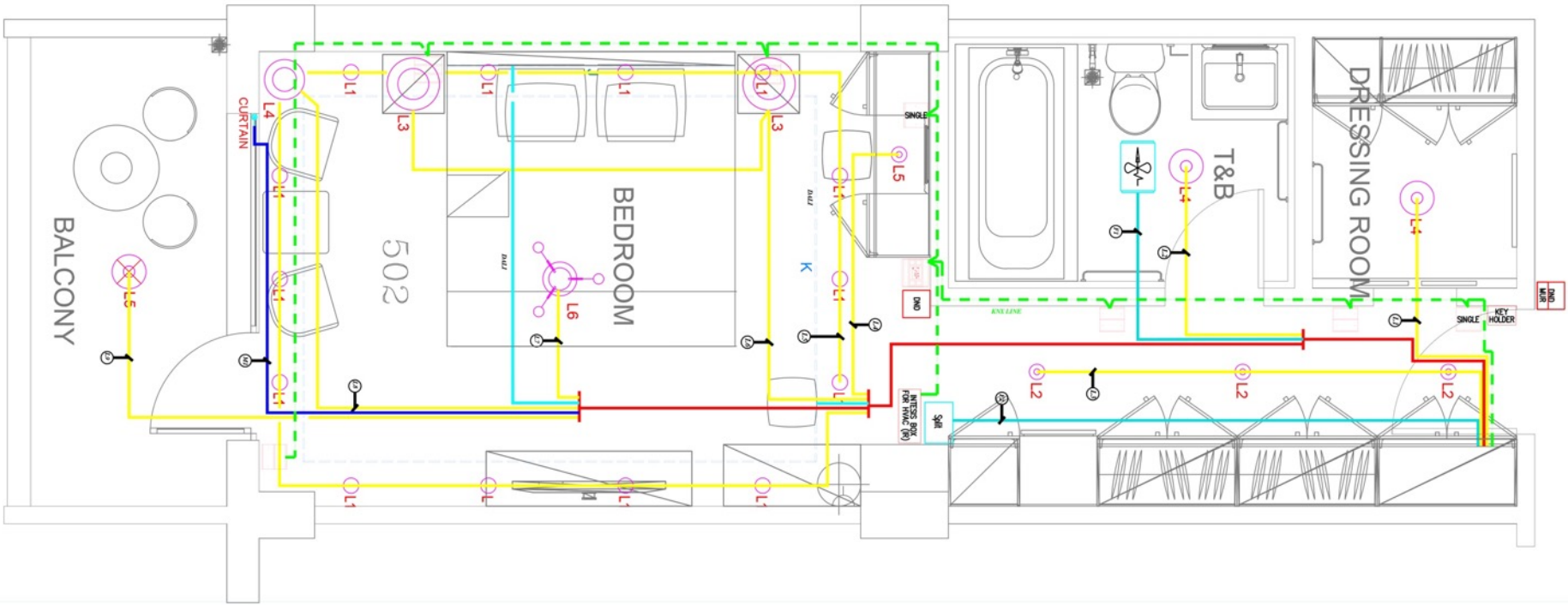





 x 1 pcs. Shutter/Blind

 x 1 pcs. Air Conditioner

# SAMPLE HOTEL ROOM – Guest Room Management System



### Package Included

	EAE DM100 DND MUR	x 1 Pcs.
	EAE ROSA DND	x 1 Pcs.
	EAE CH100 Card Holder	x 1 Pcs.
	EAE Oria Thermostat (2 Fold)	x 1 Pcs.
	EAE Oria Switch (3 Fold)	x 1 Pcs.
	EAE Oria Switch (2 Fold)	x 3 Pcs.
	EAE Oria Switch (Single)	x 2 Pcs.
	EAE RCU 2018 Room Control Unit	x 1 Pcs.
	EAE DA100 Dali Gateway	x 1 Pcs.
	EAE IPR100 IP Router	x 1 Pcs.
	EAE PSU640 Power Supply	x 1 Pcs.
	HVAC KNX GATEWAY	x 1 Pcs.

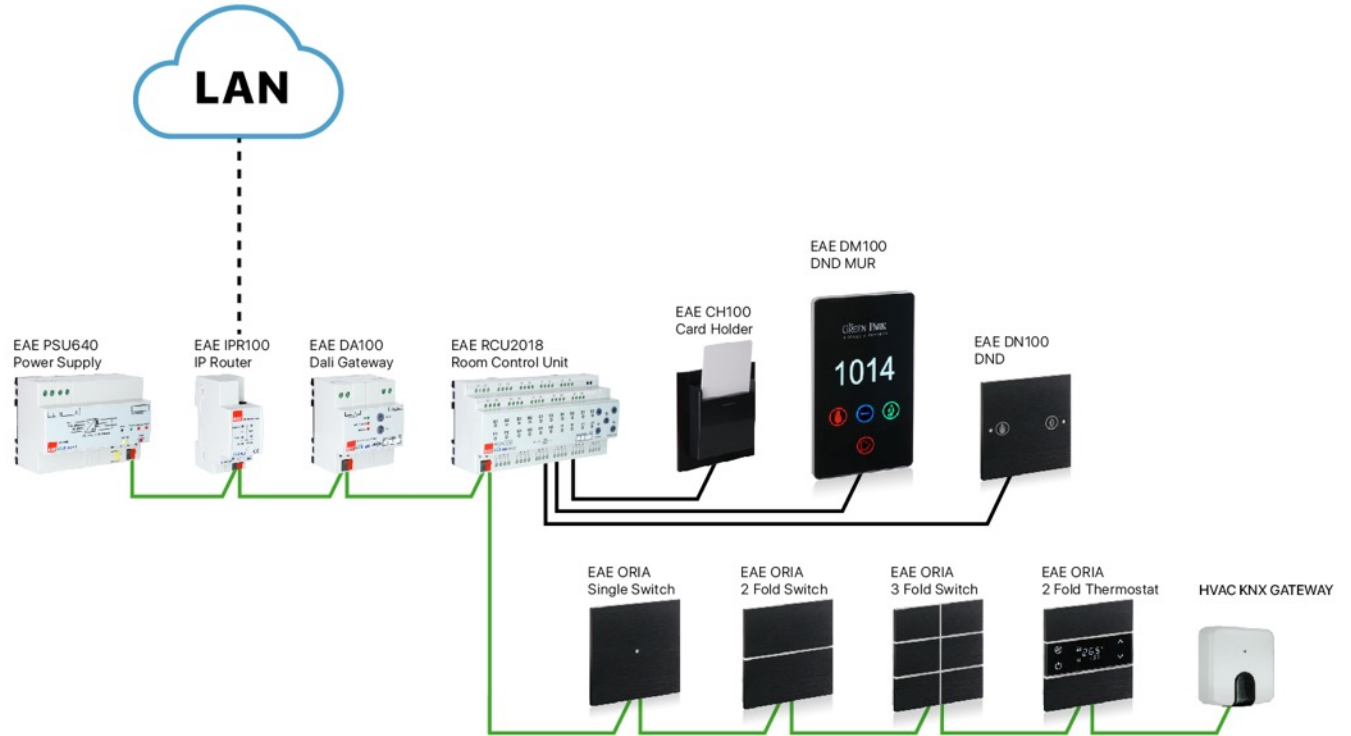



## RISER DIAGRAM

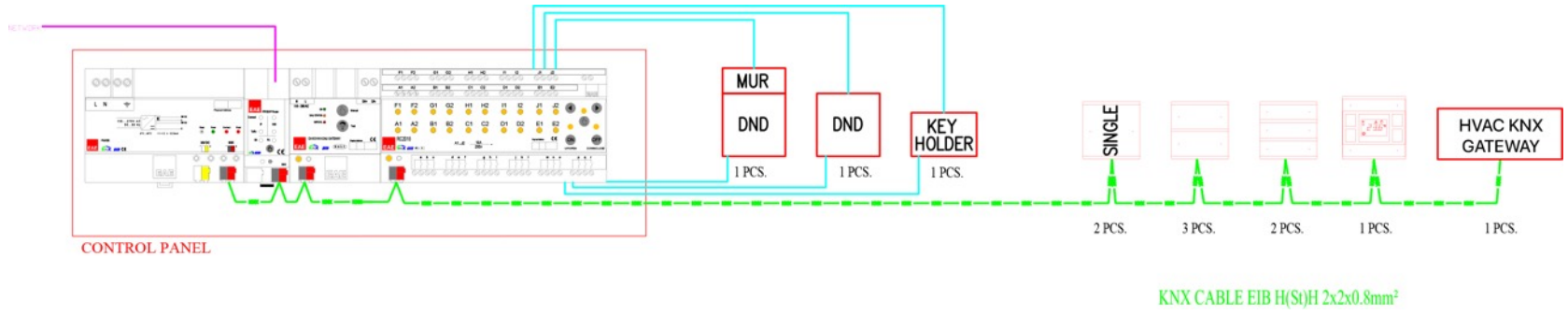

## SINGLE LINE DIAGRAM

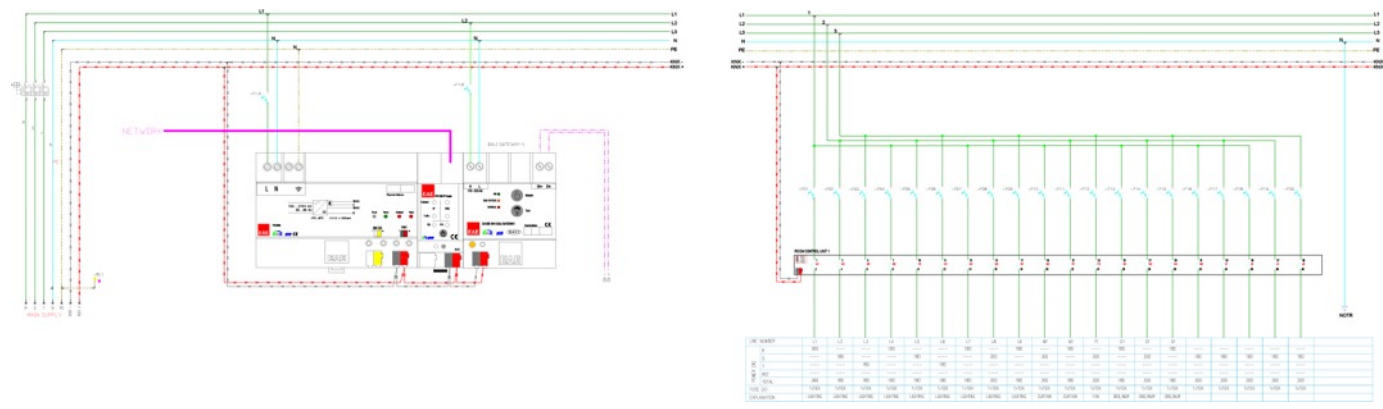

The 'rosa' logo, with a stylized 'r' icon to the left of the word 'rosa' in a bold, lowercase font.

Thermostat  
Switch  
Socket



Simple Touch, Unlimited Comfort

# thermostats

- Lighting,
- Curtain / blinds,
- Heating-cooling,
- Stage call,
- Speaker,
- Panic button



The 'rosa' logo, with a stylized 'r' icon to the left of the word 'rosa' in a bold, lowercase font.

Thermostat  
Switch  
Socket

## Simple Touch, Unlimited Comfort switches

- Lighting,
- Shutter-blind,
- Speaker,
- Scene call,
- Heating cooling control,
- Panic button control...



**rosa** *glass* Thermostat  
Switch  
Socket



## Simple Touch, Unlimited Comfort

# thermostats

- Lighting,
- Curtain / blinds,
- Heating-cooling,
- Stage call,
- Speaker,
- Panic button





The logo for 'rosa glass', with 'rosa' in a bold, sans-serif font and 'glass' in a cursive script font.

Thermostat  
Switch  
Socket



## Simple Touch, Unlimited Comfort switches

- Lighting,
- Shutter-blind,
- Speaker,
- Scene call,
- Heating cooling control,
- Panic button control...





Thermostat  
Switch  
Socket



Simple Touch, Unlimited Comfort

# thermostats

- Lighting,
- Curtain / blinds,
- Heating-cooling,
- Stage call,
- Speaker,
- Panic button





Thermostat  
Switch  
Socket



## Simple touch, unlimited comfort switches

- Lighting,
- Shutter-blind,
- Speaker,
- Scene call,
- Heating cooling control,
- Panic button control...



# THERMOSTAT and SWITCH ICON OPTIONS



**Light On / Off**



**Light Enhance / Dim**



**Volume Increase / Decrease**



**Scene**



**Shutter-Blind**



**Shutter-Blind Wing**



**Away - Stay**





# DM100

EAE DND MUR



## GENERAL SPECIFICATIONS

- Information display with built-in touch buzzer button showing room status information.
- Suitable for flush mounting.
- The Ring function will disable, when the Do not disturb message receive.
- The internal standard commutator or touchscreen can be controlled by its own indoor unit. (OBE30 - OBE40)
- Bell output.
- Blue / red interior lighting
- Indicates that the room is full with information from the energy control unit.
- 220V AC mains voltage can work directly without adapter.
- 0-50C 0-80% ambient operating values

# CH100

EAE CARD HOLDER



## GENERAL SPECIFICATIONS

- The card reader module of the ES 3016 in-board rail-mounted energy controller set.
- Mifare 13.56 Mhz card sensitive (optionally 125 KHz).
- Reads card information in contactless RF. There won't be mechanical wear and card deformation.
- It is sensitive to hotel cards it do not work with normal cards, provides full energy savings.
- It can be used with its own module and other card slot can be installed.
- Detection distance up to 50mm.
- Red / blue led light.
- Can be mount up to 20m from the panel module.

# RCU2018

EAE KNX – ROOM CONTROL UNIT



## GENERAL SPECIFICATIONS

- Special design for different room layouts
- Meet the needs of all electrical installation applications that may be use in the room
- The RCU2018 has 20x16A relay output
- Switching resistive and inductive loads
- 18 independent input channels

# PD100 / MD100

EAE KNX - SENSOR

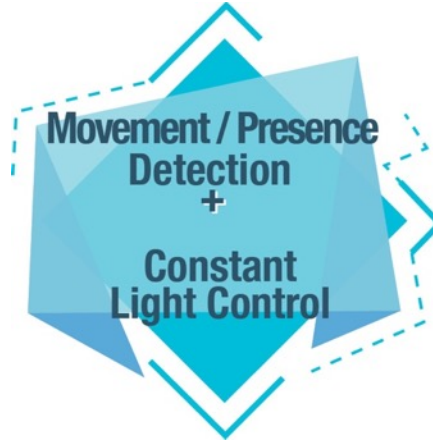

## GENERAL SPECIFICATIONS

- Surface mounting and flush mounting option
- 2-point fixed-light control
- Independent HVAC duct
- Independent asset tracking channel
- Master / slave Fully automatic / Semi-automatic operation modes
- Easy calibration mode
- Motion detection at 2.5 m mounting height, 9 m diameter

# IPR100

EAE KNX – IP ROUTER



## GENERAL SPECIFICATIONS

- Can be used as line coupler
- 4 KNXnet / IP connections can be created at the same time
- Connect to two separate KNX installations
- IP address can be supplied by DHCP server or manual configuration
- Blocking or forwarding telegrams between the KNX line and the IP part
- 6-LED operation status display



# DA100

EAE KNX – DALI GATEWAY



## GENERAL SPECIFICATIONS

- Configurable with ETS3 / ETS4 / ETS5
- 64 Lighting Stage
- 16 Group Control
- DA100 can use up to 8 DALI sensors
- Error status of DALI devices, device-based and group-based, with different KNX communication objects
- Intersecting DALI groups

# SD110

EAE KNX - 0-10V / 1-10V DIM ACTUATOR

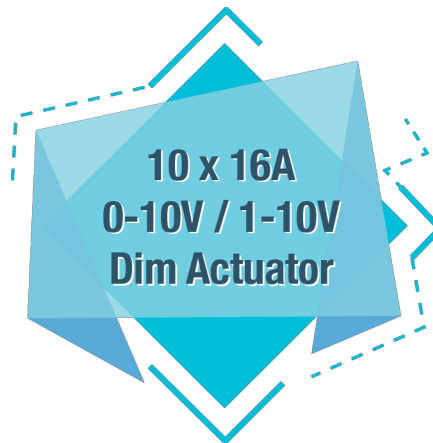

## GENERAL SPECIFICATIONS

- 10 independent channels that can be parameterized via ETS4/ETS5.
- Manual operation feature for each channel using membrane switches.
- Each channel can actualize any of these functions separately.
- Following function list provided;
  - Staircase, • Scene, • Operating Hour, • Forced Operation
- Configurable behaviour after voltage return, voltage failure or ETS download
- Integrated relay on each channel for complete switch off
- Does not require an additional power supply.

# UD105

EAE KNX – UNIVERSAL DIM ACTUATOR



## GENERAL SPECIFICATIONS

- Incandescent lamp, halogen lamp, dimmable LED and fluorescent lamps can be dimmed up to 1500W in 5 parallel channels.
- Flexibility to connect loads even below 1W (LED bulbs) without any lower limit
- 10 independent channels that can be parameterized via ETS4/ETS5.
- Manual operation feature for each channel using membrane switches.
- Each channel can actualize any of these functions separately.
- Following function list provided;
  - Staircase.
  - Scene
  - Operating Hour
  - Forced Operation
- Configurable behaviour after voltage return, voltage failure or ETS download.

# PS320 / PS640

EAE KNX – POWER SUPPLY



## GENERAL SPECIFICATIONS

- Two models with 320mA and 640mA output
- 150-275V AC, 50-60Hz input voltage range
- The device has two power outputs.
- Output 1: Provides KNX bus line feed with built-in choke coil. (30VDC, SELV)
- Output 2: External auxiliary supply output. (30VDC, SELV)
- Power, Overload, Reset states on 3 different led displays

# MARRIOTT Le MERIDIEN HOTEL Batumi - Georgia



Le MERIDIEN

*Project Name:*

**Marriott Le Meridien Hotel**

*Location:*

**Georgia**

*Number of Used Devices:*

**1000+ Pcs**





# EDIFICIO AMAYA SPAIN



*Project Name:*  
**Edificio Amaya Apartments**  
*Location:*  
**Spain**  
*Number of Used Devices:*  
**500+ Pcs**



**100  
Apartments**

Hotel Concept is Applied  
to apartments  
(without DND MUR,  
Card Holder Devices)

# INVEST VADIKORU Istanbul



*Project Name:*  
**Invest VadiKoru Residences**  
*Location:*  
**Istanbul**  
*Number of Used Devices:*  
**2500+ Pcs**





# ROUTE ISTANBUL RESIDENCES Istanbul



*Project Name:*

**Route Istanbul Residences**

*Location:*

**Istanbul**

*Number of Used Devices:*

**1000+ Pcs**



# BALANCE GUNESLI Istanbul



*Project Name:*

**Balance Gunesli**

*Location:*

**Istanbul**

*Number of Used Devices:*

**1000+ Pcs**



## REFERENCES



- Park Jöven Rezidansları
- YHT İstanbul Ankara Tüneler
- Route Ataköy Rezidansları
- Kartal Dr. Lütfi Kırdar Eğitim Araştırma Hastanesi
- Çaykur Rize Fabrikası
- Milaha Logistic City
- Vadikoru Konutları
- Bursa Bölge Adliye Mahkemesi
- Adana Adliye Sarayı
- Cumhurbaşkanlığı Senfoni Orkestrası Ankara
- Bonne Ville Konutları
- Denizli Adliyesi Ek Binası
- Versus Dragos Evleri
- Doğa Lojistik
- Konya Numune Hastanesi
- THY Simulasyon Merkezi
- Balance Güneşli
- Şimşek Yapı Apartman Projesi
- Sulhi Dönmez Eğitim Merkezi
- Ankara Yüksek Seçim Kurulu Binası
- Marmara Üniversitesi C-D Blok
- Fatih SGK Binası
- Sivas Valliği Ek Hizmet Binası
- Aydoğanlar İnşaat
- Karayolları Genel Müdürlüğü Ankara
- Bağcılar Belediye Binası
- İSU Merkez Binası Projesi
- Cemal Kamacı Spor Kompleksi
- Dulkadiroğlu Belediyesi
- Brisa Aksaray
- Güngören Belediyesi
- Antalya Merkez Bankası
- Taksim İkiyıldırım 250 Yataklı Eğt. Ar. Hastanesi
- Adana Adalet Sarayı
- Teknopark Yeditepe
- Erasta Avm Edirne
- Ağrı Devlet Hastanesi
- Tandem Tekstil
- Aski Sular İdaresi
- Beyoğlu SGK
- Oğulbey Depo
- UPS Kargo Binası
- Adıyaman Avm
- TEI Tusaş B-300 / B-700 / B1000
- Unipress
- Bayrak Lastik
- Alvimedika İlaç Fabrikası
- Garanti Konutları
- Eryaman\_Osmanlıspor\_Stadyumu
- Sarıyer Devlet Hastanesi
- İldem AVM
- B/S/H
- Kazıcıoğlu Otomatik Aydınlatma
- Hasanpaşa Katlı Otopark
- Anadolu Ofis
- Nun Koleji Beykoz Kampüsü
- Sude Su
- Gebze Mevlana Pazar Alanı
- İnan Makina
- Fortis Sinanlı
- Gebze Ulus Poliklinik
- İstanbul Gençlik ve Spor Müd. İdari Bina
- Eczacıbaşı Vitra Depo
- Küçükçalık Tekstil
- Ceha Büro Mobilyaları
- Bosch Fren Sistemleri Fab.
- Ziraat Bankası Data Merkezi
- Yalova Ro-Ro Limanı
- Bayık Demir
- İş GYO Ankara Kuleler
- London Docks Lighting Control
- İzmit Planeteryum
- Mercedes Benz Hol 1/2/3/4/5
- Nidapark Kayışehir
- Altınbaş Üniversitesi
- Bosch Hdev6
- NG Kütahya Porselen Seramik
- Ekol Koleji
- Safiport Derince
- Kısıklı Villa
- Asaş Alüminyum Büyüme Alanı
- Beycelik Gestamp Fabrika
- Bursa Arkeopark Aktopraklık Höyüğü Müzesi
- Sincan Etimesgut Tapu Binası
- BYZ Avm
- Gebze Adem Yavuz Pazar Alanı
- Türk Traktör
- Tanap Gölbaşı
- Metropol Yapı Denetim Merkez Ofis
- Sarp Sınır Kapısı
- Guhem Uzak Havacılık
- Mercedes Metalsa
- Farba Bulgaristan
- Vialand
- Sadıkoğlu İnşaat Apartman Projesi
- Henkel Anatolia
- Natuk Birkan Spor Salonu
- Aygersan Farba Kazan Fabrika
- Ted Üniversitesi
- Ptt Data Merkezi
- Ford
- Migros
- Küçükbakırcı Metal
- Urfa Park
- Bezmialem Üniversitesi
- Erhallar Market
- 3. Havalimanı Datacenter
- Pulver Kimya Sanayi Yönetim Binası
- Sönmez Metal Ofis Projesi
- Eti Yönetim Binası
- Türk Telekom Karamancılar Genel Müdürlüğü
- Segatech
- Ekol Lavanta
- Man Polonya
- Korozo Çorlu
- Barut Cennet Otel
- İbb Living Lab Deneyim Merkezi
- Balıkesir Sgk
- Safranbolu Hilton Garden British Pub
- Cenal Termik Santral
- Coşkunöz Süğ Binası
- Rekor Kaçuk
- Fnsş Nurol Makina Boyahane
- Prodar Aydınlatma
- Aski Genel Müdürlüğü
- Özgün Matbaa
- Nelit Teknoloji
- Tofaş
- TAI Türk Havacılık ve Uzak Sanayi
- Benesta Acıbadem
- İky Maket Ofis
- Bakü Paulaner Restaurant
- Oğm Afet Merkezi
- Ömerli Villa
- Philip Morris İnternation
- Çukurcuma Hamamı
- Konya Şeker
- Bartek
- Dalikin
- Tüyap Balo Salonu
- Arçelik Kompresör Binası
- Koçtaş Mağazaları
- Gayda Ataşehir Konutları
- Konya Tarım Ve Gıda Üni. Doğa Bilimleri Fakültesi
- Tofaş Akademi Bakımcı Okulları
- Türk Telekom
- Alanya Adliyesi



# CERTIFICATES



**CE** **EAE**  
**DECLARATION OF CONFORMITY**

EAE Teknoloji Araştırma ve Geliştirme San. ve Tic. A.Ş.  
Kuvang Sönmez Bulvarı EAE Targem Opeti Çarşı No:20 Beşiktaş  
80100/1 - 34397  
TÜRKİYE

Doc. Number: F20111-CE-1

This is to certify that the following product type:

UNIVERSAL INTERFACE 110M  
SMP 11001 EAE S.001

Are produced in conformity with the safety directives:

2006/95/EC (EMC)  
2014/53/EU (RED)

And in conformity with general requirements of the standards:

EN 50491-2-2:2008  
EN 50491-2-3:2010  
EN 51004-2-2:2009  
EN 51004-2-3:2007

Initially issued at: 19.03.2014  
Rev. No : 3  
Rev.Date : 09.02.2015  
İstanbul, Turkey

General Manager  
Kuvang SÖNMEZ

**CE** **EAE**  
**DECLARATION OF CONFORMITY**

EAE Teknoloji Araştırma ve Geliştirme San. ve Tic. A.Ş.  
Kuvang Sönmez Bulvarı EAE Targem Opeti Çarşı No:20 Beşiktaş  
80100/1 - 34397  
TÜRKİYE

Doc. Number: F20111-CE-1

This is to certify that the following product type:

Dsl Gateway S.030  
SMP 30101 EAE S.001

Are produced in conformity with the safety Directives:

2006/95/EC (EMC)  
2014/53/EU (RED)

And in conformity with general requirements of the Standards EN:

EN 50491-2-2:2008  
EN 50491-2-3:2010  
EN 51004-2-2:2009  
EN 51004-2-3:2007

EN 51004-4-2:2007+A1:2011  
EN 50864-4-2:2007

Initially issued at: 19.03.2014  
Rev. No : 4  
Rev.Date : 19.03.2015  
İstanbul, Turkey

General Manager  
Kuvang SÖNMEZ

**CE** **EAE**  
**DECLARATION OF CONFORMITY**

EAE Teknoloji Araştırma ve Geliştirme San. ve Tic. A.Ş.  
Kuvang Sönmez Bulvarı EAE Targem Opeti Çarşı No:20 Beşiktaş  
80100/1 - 34397  
TÜRKİYE

Doc. Number: F20111-CE-1

This is to certify that the following product type:

PRESENCE DETECTION DEVICE  
SMP 01001 EAE S.001

Are produced in conformity with directives below:

Directive 2004/108/EC (EMC)  
2006/95/EC (EMC)  
2014/53/EU (RED)

EN 50491-2-2:2008  
EN 50491-2-3:2010  
EN 51004-2-2:2009  
EN 51004-2-3:2007

EN 50423:2007+A1:2007+A2:2007

EN 50603:2009  
EN 50623:2007+A1:2007+A2:2007

Initially issued at: 19.03.2015  
Rev. No : 1  
Rev.Date : 1  
İstanbul, Turkey

General Manager  
Kuvang SÖNMEZ

**CERTIFICATE OF CONFORMITY**

CERTIFICATE No: 2007172014

Delivered to:  
EAE TEKNOLOJİ ARAŞTIRMA GELİŞTİRME SANAYİ TİC.A.Ş.  
Kuvang Sönmez Bulvarı EAE Targem Opeti Çarşı No:20 Beşiktaş  
TR-34397 İstanbul  
TURKEY

This is to certify that the underneath listed product:

**IP1810 IP Router**  
Order number: 8005  
Application program: SW1810  
EMC type: 800 type  
EMC type: 800 type

Are produced in conformity with the safety directives below:  
2006/95/EC (EMC)  
2014/53/EU (RED)

EN 50491-2-2:2008  
EN 50491-2-3:2010  
EN 51004-2-2:2009  
EN 51004-2-3:2007

EN 50423:2007+A1:2007+A2:2007

EN 50603:2009  
EN 50623:2007+A1:2007+A2:2007

Initially issued at: 09.03.2015  
Rev. No : 1  
Rev.Date : 1  
İstanbul, Turkey

General Manager  
Kuvang SÖNMEZ

Chair Technical Officer  
KNX ASSOCIATION office

Doc. No: 2015-010

www.knx.org

© The website: STANBAE for home and building control

**CERTIFICATE OF CONFORMITY**

CERTIFICATE No: 2007181013

Delivered to:  
EAE TEKNOLOJİ ARAŞTIRMA GELİŞTİRME SANAYİ TİC.A.Ş.  
Kuvang Sönmez Bulvarı EAE Targem Opeti Çarşı No:20 Beşiktaş  
TR-34397 İstanbul  
TURKEY

This is to certify that the underneath listed product:

**UI105 Universal Interface, 8-Channel**  
Order number: 8005  
Application program: Universal Interface, 8-Channel, L1  
EMC type: 800 type  
EMC type: 800 type

Are produced in conformity with the safety directives below:  
2006/95/EC (EMC)  
2014/53/EU (RED)

EN 50491-2-2:2008  
EN 50491-2-3:2010  
EN 51004-2-2:2009  
EN 51004-2-3:2007

EN 50423:2007+A1:2007+A2:2007

EN 50603:2009  
EN 50623:2007+A1:2007+A2:2007

Initially issued at: 09.03.2015  
Rev. No : 1  
Rev.Date : 1  
İstanbul, Turkey

General Manager  
Kuvang SÖNMEZ

Chair Technical Officer  
KNX ASSOCIATION office

Doc. No: 2015-010

www.knx.org

© The website: STANBAE for home and building control

**CE** **EAE**  
**DECLARATION OF CONFORMITY**

EAE Teknoloji Araştırma ve Geliştirme San. ve Tic. A.Ş.  
Kuvang Sönmez Bulvarı EAE Targem Opeti Çarşı No:20 Beşiktaş  
80100/1 - 34397  
TÜRKİYE

Doc. Number: F20111-CE-1

This is to certify that the following product type:

KNX IP ROUTER IP1810  
SMP IP1810 EAE S.001

Are produced in conformity with the safety directives:

2006/95/EC (EMC)  
2014/53/EU (RED)

And in conformity with general requirements of the standards:

EN 50491-2-2:2008  
EN 50491-2-3:2010  
EN 51004-2-2:2009  
EN 51004-2-3:2007

EN 50864-4-2:2007

EN 50863-4-1:2009+A1:2009  
EN 50863-4-2:2009  
EN 50861-2012

Initially issued at: 09.02.2015  
Rev. No : 3  
Rev.Date : 19.03.2015  
İstanbul, Turkey

General Manager  
Kuvang SÖNMEZ

**CE** **EAE**  
**DECLARATION OF CONFORMITY**

EAE Teknoloji Araştırma ve Geliştirme San. ve Tic. A.Ş.  
Kuvang Sönmez Bulvarı EAE Targem Opeti Çarşı No:20 Beşiktaş  
80100/1 - 34397  
TÜRKİYE

Doc. Number: F20111-CE-1

This is to certify that the following product type:

KNX IP INTERFACE 1P1010  
SMP IP1010 EAE S.001

Are produced in conformity with the safety Directives:

2006/95/EC (EMC)  
2014/53/EU (RED)

And in conformity with general requirements of the standards :

EN 50491-2-2:2008  
EN 50491-2-3:2010  
EN 51004-2-2:2009  
EN 51004-2-3:2007

EN 50863-4-1:2009+A1:2009  
EN 50863-4-2:2009  
EN 50861-2012

Initially issued at: 09.02.2015  
Rev. No : 4  
Rev.Date : 19.03.2015  
İstanbul, Turkey

General Manager  
Kuvang SÖNMEZ

**CE** **EAE**  
**DECLARATION OF CONFORMITY**

EAE Teknoloji Araştırma ve Geliştirme San. ve Tic. A.Ş.  
Kuvang Sönmez Bulvarı EAE Targem Opeti Çarşı No:20 Beşiktaş  
80100/1 - 34397  
TÜRKİYE

Doc. Number: F20111-CE-1

This is to certify that the following product type:

KNX SWITCH ACTUATOR SW108  
SMP SW108 EAE S.001

Are produced in conformity with the safety directives:

2006/95/EC (EMC)  
2014/53/EU (RED)

And in conformity with general requirements of the standards :

EN 50491-2-2:2008  
EN 50491-2-3:2010  
EN 51004-2-2:2009  
EN 51004-2-3:2007

EN 50423:2007+A1:2007+A2:2007

EN 50603:2009  
EN 50623:2007+A1:2007+A2:2007

Initially issued at: 09.03.2014  
Rev. No : 4  
Rev.Date : 19.03.2015  
İstanbul, Turkey

General Manager  
Kuvang SÖNMEZ

**CERTIFICATE OF CONFORMITY**

CERTIFICATE No: 2007171013

Delivered to:  
EAE TEKNOLOJİ ARAŞTIRMA GELİŞTİRME SANAYİ TİC.A.Ş.  
Kuvang Sönmez Bulvarı EAE Targem Opeti Çarşı No:20 Beşiktaş  
TR-34397 İstanbul  
TURKEY

This is to certify that the underneath listed product:

**SW108 Switch Actuator 8-Channel 16A**  
Order number: 8005  
Application program: Switch Actuator 8-Channel 16A, L1  
EMC type: 800 type  
EMC type: 800 type

Are produced in conformity with the safety directives below:  
2006/95/EC (EMC)  
2014/53/EU (RED)

EN 50491-2-2:2008  
EN 50491-2-3:2010  
EN 51004-2-2:2009  
EN 51004-2-3:2007

EN 50423:2007+A1:2007+A2:2007

EN 50603:2009  
EN 50623:2007+A1:2007+A2:2007

Initially issued at: 09.03.2014  
Rev. No : 4  
Rev.Date : 19.03.2015  
İstanbul, Turkey

General Manager  
Kuvang SÖNMEZ

Chair Technical Officer  
KNX ASSOCIATION office

Doc. No: 2015-010

www.knx.org

© The website: STANBAE for home and building control

**CERTIFICATE OF CONFORMITY**

CERTIFICATE No: 2007181014

Delivered to:  
EAE TEKNOLOJİ ARAŞTIRMA GELİŞTİRME SANAYİ TİC.A.Ş.  
Kuvang Sönmez Bulvarı EAE Targem Opeti Çarşı No:20 Beşiktaş  
TR-34397 İstanbul  
TURKEY

This is to certify that the underneath listed product:

**DA180 DALI Gateway 8-Scene 30W Emergency Light**  
Order number: 8005  
Application program: DALI Gateway 8-Scene 30W Emergency Light, L1  
EMC type: 800 type  
EMC type: 800 type

Are produced in conformity with the safety directives below:  
2006/95/EC (EMC)  
2014/53/EU (RED)

EN 50491-2-2:2008  
EN 50491-2-3:2010  
EN 51004-2-2:2009  
EN 51004-2-3:2007

EN 50423:2007+A1:2007+A2:2007

EN 50603:2009  
EN 50623:2007+A1:2007+A2:2007

Initially issued at: 09.03.2015  
Rev. No : 1  
Rev.Date : 19.03.2015  
İstanbul, Turkey

General Manager  
Kuvang SÖNMEZ

Chair Technical Officer  
KNX ASSOCIATION office

Doc. No: 2015-010

www.knx.org

© The website: STANBAE for home and building control



*Thank you...*

[www.eaetechnology.com](http://www.eaetechnology.com)